

Pull Bar

Dent Pulling System PB-10

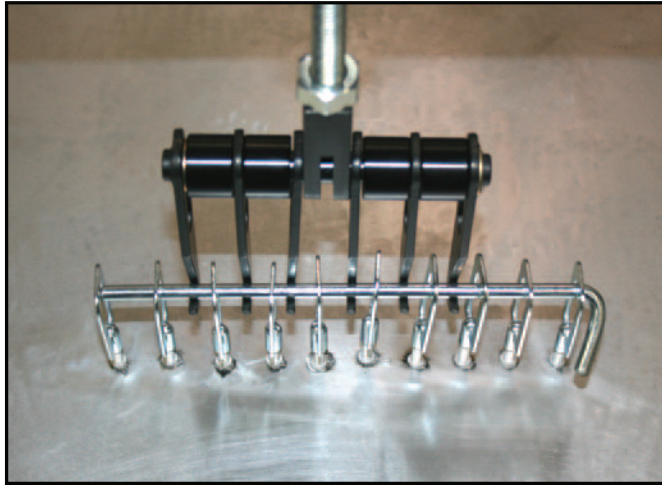

Designed for both aluminum & steel dent pulling. Our new Pull Bar features a 4 & 6 Jaw clamp, and adjustable foot swivel pads for mounting both vertically & horizontally. The dent pull bar makes dent pulling extremely easy, quick & accurate. The pull bar can also adapt to the Pro Pull system for isolated dent pulling.

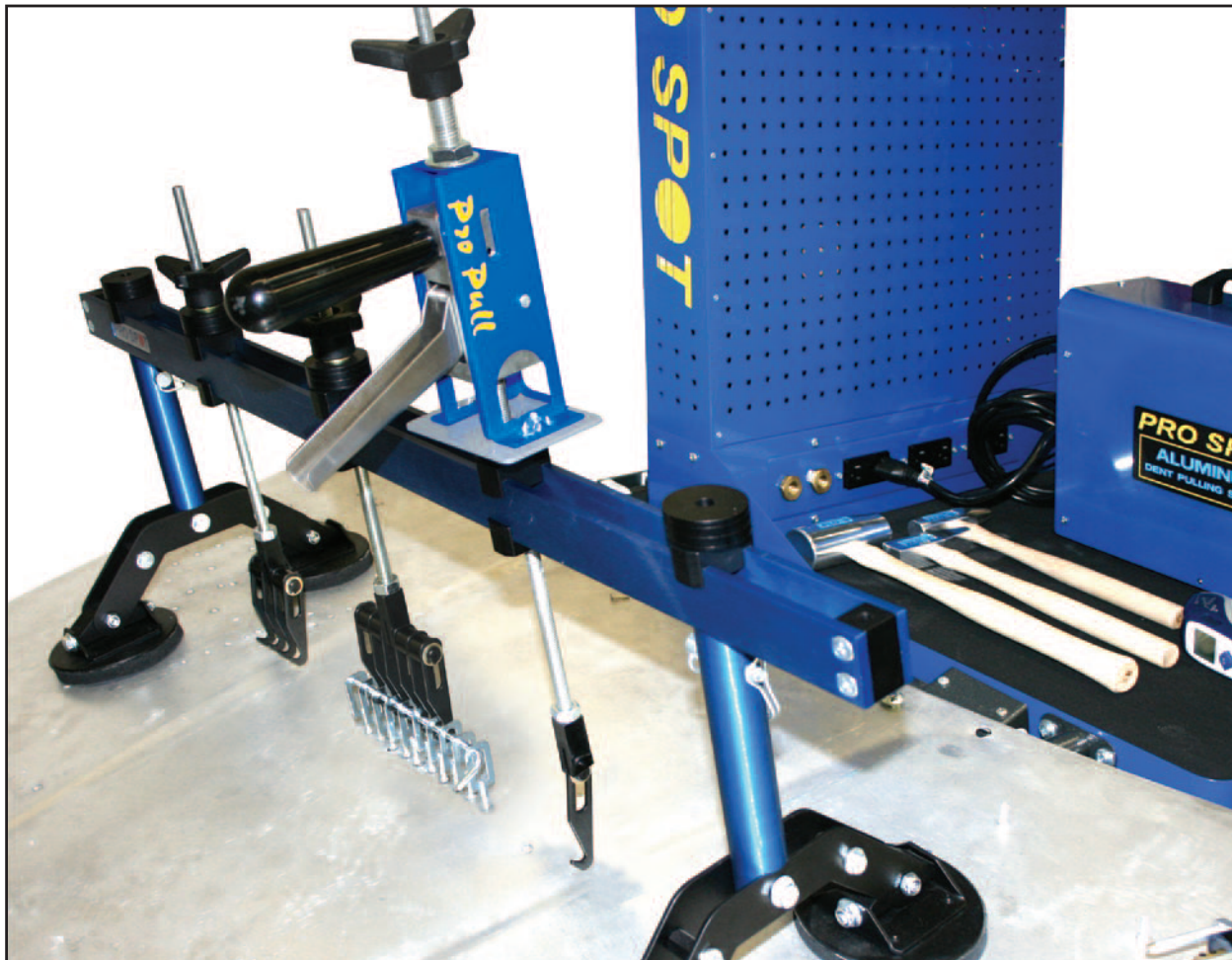

Features

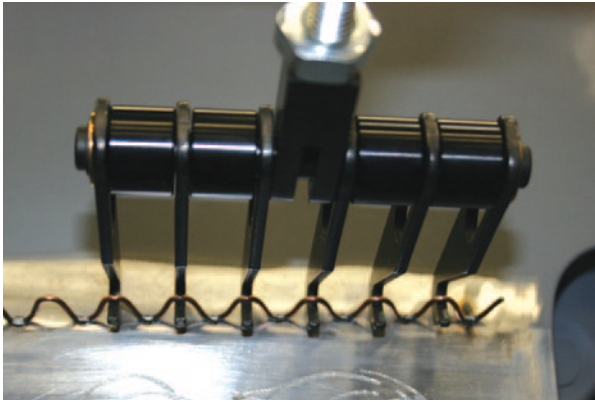

Wiggle wire dent pulling.
Wiggle wire (optional) 50-0508

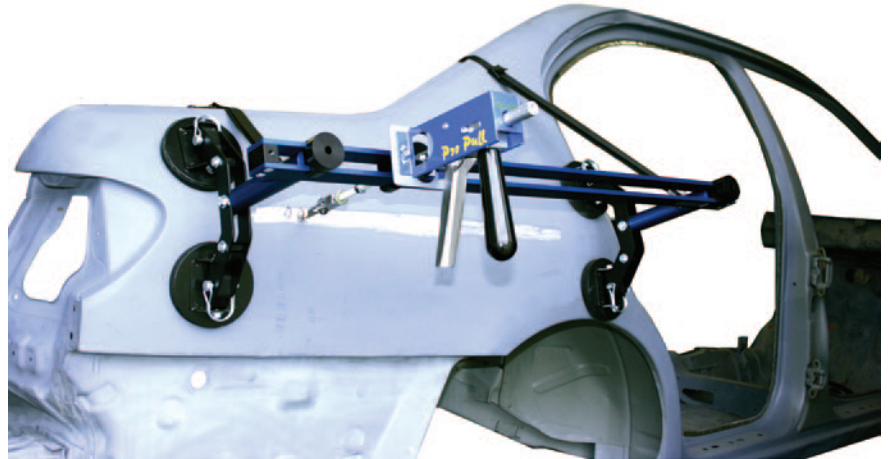

4 & 6 Jaw clamp, and adjustable foot swivel pads for mounting both vertically & horizontally.

Accessories



SA - 0018
4 Jaw Clamp



SA - 0017
6 Jaw Clamp

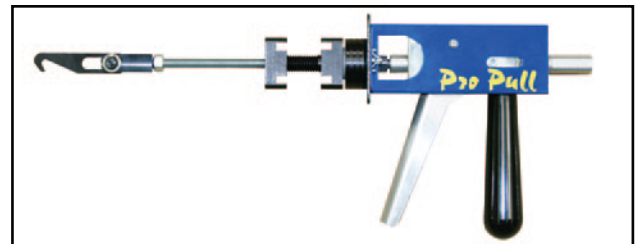

PR0-66 Pro Pull Dent Puller (optional)

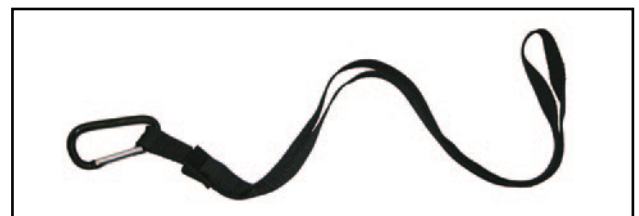

Vertical Mounting Straps 2 ea.
90-0032

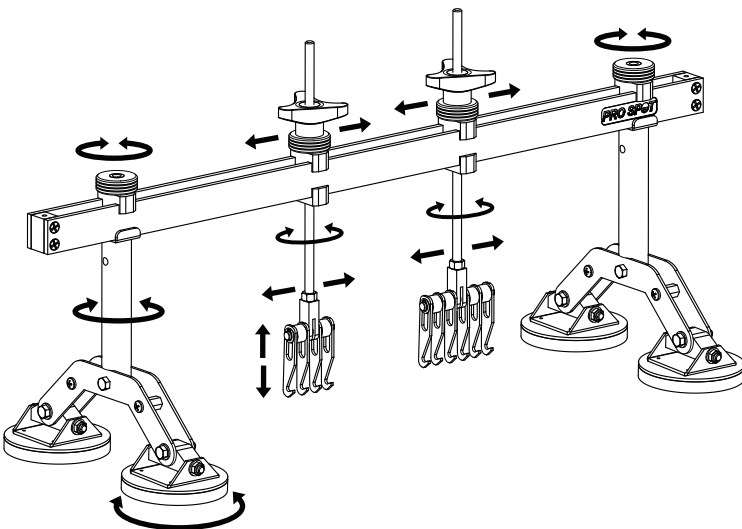

Imported and Distributed by
Prospot Australia

22 Montefiore Street, Fairfield VIC 3078

www.prospot.com.au

sales@prospot.com.au

Toll Free : 1800 287 776